

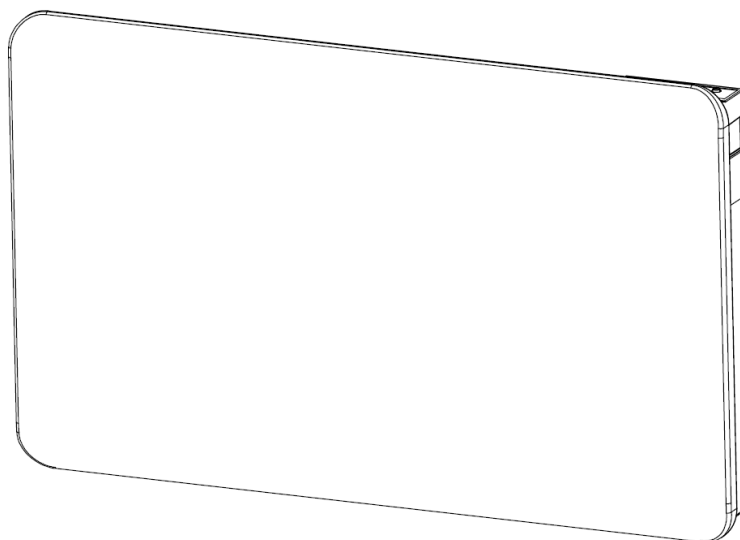

MANUAL INSTRUCTIONS

ODET Electric Radiator



This instruction manual applies to the following products:

EODT060A/EODT060W, EODT082A/EODT082W, EODT099A/ EODT099W

Important!

- **NEVER TOUCH YOUR HEATER OR ITS CASING WITH WET HANDS!**
- **DO NOT COVER THE HEATER!**

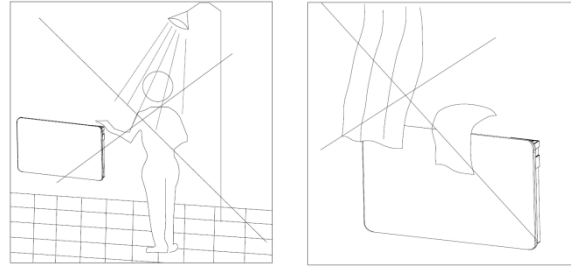

- When using any electrical device, be sure to follow basic safety precautions, such as the instructions in this instruction manual.

General safety instructions

- **PLEASE READ THE FOLLOWING INSTRUCTIONS CAREFULLY BEFORE USING THE APPLIANCE.**
- Read this manual carefully before using the device.
- Check that the mains voltage corresponds to that of the device.
- Do not use the appliance if the cable is damaged.
- Keep this unit and its cord away from sources of heat, sharp objects, or anything that could damage it.
- If the supply cord is damaged, it must be replaced by the manufacturer, its service agent or similarly qualified persons in order to avoid a hazard.
- Before connecting the unit to the power supply, make sure that the switch is “Off”.
- Turn off the power and isolate it from the power supply before cleaning or before working.
- Always place the unit on a stable, level surface and use it in an upright position.
- Do not operate the unit in areas where gasoline, paint or other flammable liquids may be used or stored.
- For indoor use only.





- To prevent a fire, do not block the air inlet and outlet in any way.
- Do not touch hot surfaces.
- Do not insert or allow foreign objects to enter any ventilation or exhaust opening as this will cause electric shock or fire and damage the unit.
- Always make sure your hands are dry before adjusting any switch or touching the unit.
- This appliance can be used by children aged from 8 years and above and persons with reduced physical, sensory or mental capabilities or lack of experience and knowledge if they have been given supervision or instruction concerning use of the appliance in a safe way and understand the hazards involved. Children shall not play with the appliance. Cleaning and user maintenance shall not be made by children without supervision.
- Children of less than 3 years should be kept away unless continuously supervised.
- Children aged from 3 years and less than 8 years shall only switch on/off the appliance provided that it has been placed or installed in its intended normal operating position and they have been given supervision or instruction concerning use of the appliance in a safe way and understand the hazards involved. Children aged from 3 years and less than 8 years shall not plug in, regulate and clean the appliance or perform user maintenance.
- **CAUTION — Some parts of this product can become very hot and cause burns. Particular attention has to be given where children and vulnerable people are present.**
- The main cause of overheating is due to dust deposits or residues in the unit. Make sure these foreign bodies are removed regularly. Isolate the unit from the network and clean it by vacuuming the air inlet and the grilles.

- The heater must not be located immediately below a socket-outlet.
- When the product is used as fixed heater: The heater is to be installed so that switches and other controls cannot be touched by a person in the bath or shower.



- **WARNING: In order to avoid overheating, do not cover the heater.**
- For the information of installation and maintenance, refer to the “INSTALLATION” section and “MAINTENANCE” section.
- Do not use the unit with a timer, timer, separate remote control system, or any other device that automatically turns on the unit, as there is a risk of fire if the unit is covered or placed incorrectly.
- **WARNING!** In order to avoid any danger due to the accidental reset of the thermal circuit breaker, the device must not be powered via an external switch, such as a timer, or be connected to a circuit which is regularly switched on and off by the electricity supplier.
- The appliance must not be disposed of with household waste; it must be brought to a local center for the recovery and recycling of electrical appliances.
- When installing the heater on its support, you must ensure that the electrical cable does not come into contact with the metal casing of the heater.

Description of symbols

	Complies with European regulations applying to the product.
	WARNING: In order to avoid overheating, do not cover the heater.
	Electrical products should not be disposed of with household waste. Please recycle them at the collection points provided for this purpose. Contact the local authorities or your dealer for recycling advice.
	CAUTION The device may be hot, do not touch it without taking precautions.

The use of symbols in this manual is intended to draw attention to possible risks. The safety symbols and explanations that accompany them must be fully understood. The warnings themselves do not eliminate the risks and cannot replace the correct measures of accident prevention.

Technical characteristics

- LED display
- Comfort mode: temperature setting 5 ~35°C
- ECO mode: temperature setting 5 ~35°C
- Anti-freeze mode: Temperature fixed 7°C, and it can't be modified
- Week program mode
- 24 hours timer
- Open window function
- With WiFi control

Code	Names	Voltage	Power	IP rating	Class	Height(mm)	Length(mm)
EODT060W	ODET CERAMIC CORE WHITE WIFI	230 V~ 50 Hz	1000W	IP24	Class I	500	600
EODT082W	ODET CERAMIC CORE WHITE WIFI	230 V~ 50 Hz	1500W	IP24	Class I	500	820
EODT099W	ODET CERAMIC CORE WHITE WIFI	230 V~ 50 Hz	2000W	IP24	Class I	500	990
EODT060A	ODET CERAMIC CORE ANTHRACITE WIFI	230 V~ 50 Hz	1000W	IP24	Class I	500	600
EODT082A	ODET CERAMIC CORE ANTHRACITE WIFI	230 V~ 50 Hz	1500W	IP24	Class I	500	820
EODT099A	ODET CERAMIC CORE ANTHRACITE WIFI	230 V~ 50 Hz	2000W	IP24	Class I	500	990

Wall Mounted Installation

IMPORTANT! Make sure that there is no electrical wiring or other installation (water pipe for example) near the locations where the holes will be drilled. Be sure to fix the unit vertically and firmly to the wall.

This appliance is intended for indoor installation and use only.

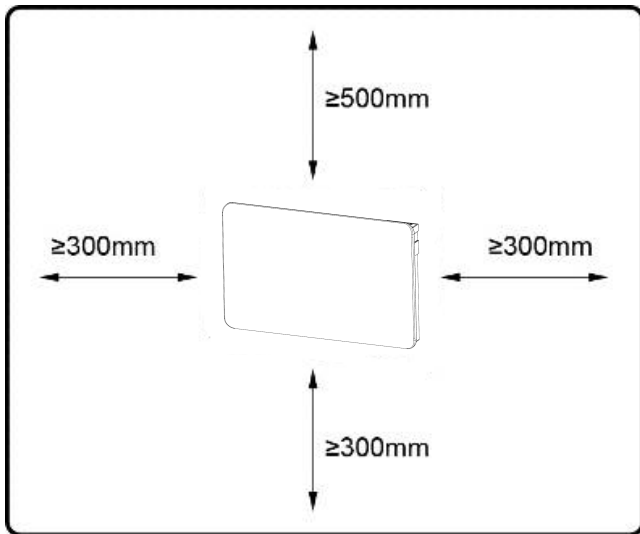

Fig. 1

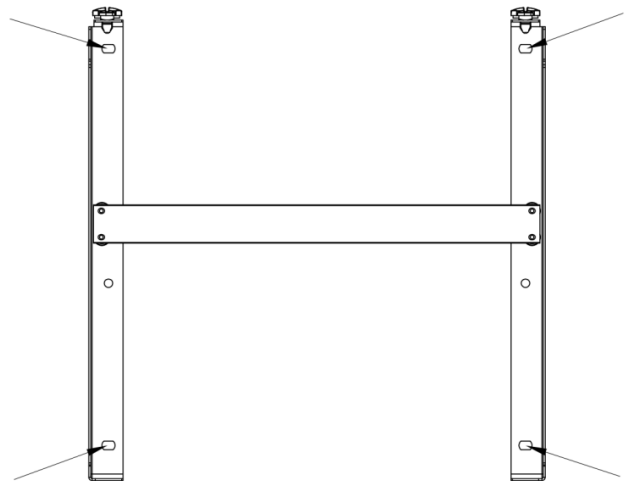

Fig. 2

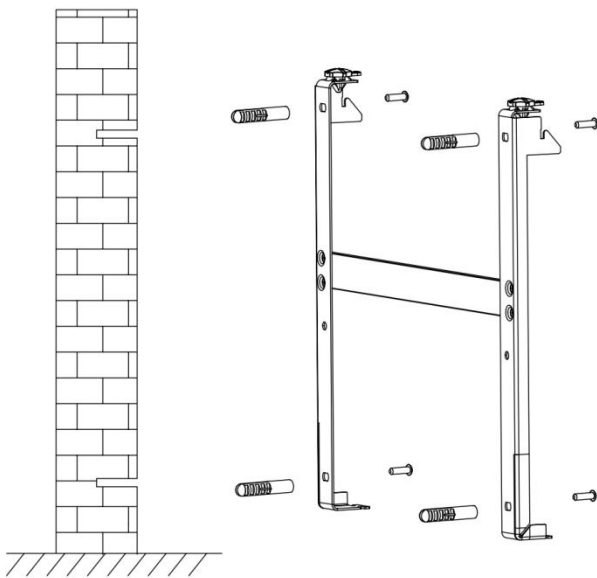

Fig. 3

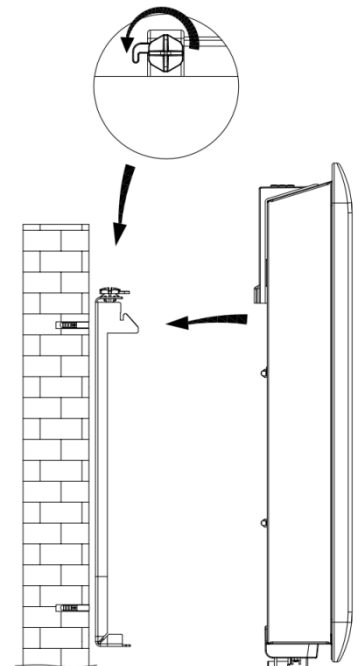

Fig. 4

1. Be sure to keep the distance between the heater and floor, wall and so on at least 30cm as Fig 1.
2. Don't use in bathroom and don't cover. Fig 2

3. Take out the H shape bracket from the back of the product. Put it on the wall and mark the 4 holes' position on the wall as Fig 2. Drill the holes($\Phi 10$) on the wall.
4. Place the anchors into the drilled holes, then fix the H shape bracket on the wall by the 4 screws. Fig 3
5. Hang the heater on the bracket, and tighten the bracket's top plastic screw. Fig 4

WARNING ! Before starting the appliance, make sure that it is properly fixed to the wall. If the device is not level, problems may occur.

Using

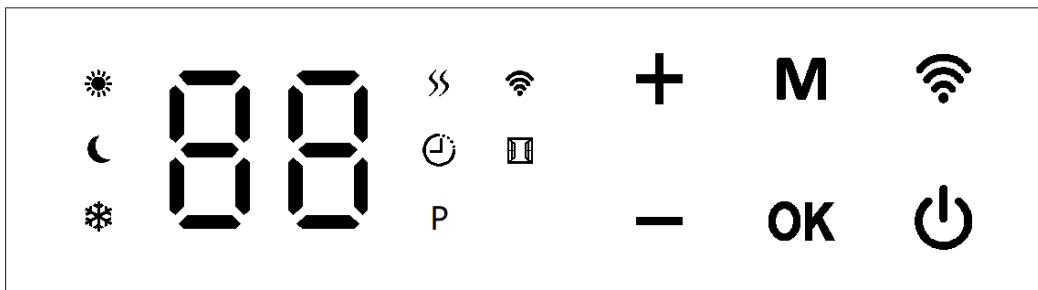

1. Control panel



	Display
	Comfort mode light
	ECO mode light
	Anti-freeze mode light
	Heating light
	Timer light
	Week program light
	WiFi light
	Open window light

	ON / OFF button
	Mode button
	Confirm button
	Increase button
	Decrease button
	WiFi button

2. Start using

- Plug in power supply, the heater enter into standby mode, and show  on display.
- Press  button to turn on the heater, and the heater will enter into comfort mode. Comfort light  is on and default setting temperature is 22°C.



In any modes, the heating light  is on if the heater is heating.

Remarks: If the power supply cut off, then after power supply come back, the heater will enter into comfort mode. Time and date need re-setting, the other setting will keep same as before.





3. Mode selection

- In comfort mode, press mode button **M** to select mode: ECO→Anti-freeze→Week program→Open window→Comfort. After selection, press **OK** button to confirm, or wait 10 seconds to confirm automatically.









4. Comfort, ECO and Anti-freeze mode

- Comfort mode: Default setting is 22°C, temperature setting range is 5 to 35°C. Press **+** and **-** button to adjust the temperature, then press **OK** button to confirm, or wait 10 seconds to confirm automatically. Comfort light  is on.
- ECO mode: Default setting is 17°C, temperature setting range is 5 to 35°C. Press **+** and **-** button to adjust the temperature, then press **OK** button to confirm, or wait 10 seconds to confirm automatically. ECO light  is on.
- Anti-freeze mode: Temperature fixed 7°C, and it can't be modified. In any modes, when room temperature is lower than 7°C, the anti-freeze function will start and the heater start heating. Anti-freeze light  is on.





5. Timer

- Please note timer function only can use in comfort and ECO mode.
- Timer range is 0 to 24 hours.
- In comfort or ECO mode, press and hold button **M** for 3 seconds, display  flash, Press **+** and **-** button to set timer hours, then press **OK** button to confirm, or wait 10 seconds to confirm automatically. Comfort light  and timer light  are on, or ECO light  and timer light  are on.
- Please note if select to other modes when timer is not finished, timer setting will cancel.

6. Week program mode









- There are 3 week program modes: P1, P2, P3.
- Running as Comfort, ECO or Anti-freeze mode in different day and time.
- Comfort, ECO and Anti-freeze temperature is same as the setting in their mode.
- P1 program can't be modified. P2 and P3 program can be modified.
- When the first time use week program mode, it must set week day, hour and minute first. Setting as below:
 - After select week program mode, display  flash, press **+** or **-** button to set week day from  to  (means Monday to Sunday), press **OK** button to confirm;
 -  flash, press **+** or **-** button to set hour from 00 to 23, press **OK** button to confirm;
 -  flash, press **+** or **-** button to set minute from 00 to 59, press **OK** button to confirm;
 -  flash, press **+** or **-** button to select P2 and P3, press **OK** button to confirm or wait 10 seconds to confirm automatically.
 - The week program light  is on. If select P1, display show  and setting temperature every 5 seconds.

- P2 modify as below:

- In P2 mode, press and hold button **M** for 3 seconds, display  flash, press **+** or **-** button to set week day from  to  (means Monday to Sunday), press **OK** button to confirm;
-  flash, press **+** or **-** button to set hour from 00 to 24, press **OK** button to confirm;
- Comfort, ECO and anti-freeze light flash, press **+** button to select mode, press **OK** button to confirm.
- Continue to set next time period's mode until to 24;
-  flash, continue to set next day, until all 7 days are set.

- P3 is same setting as P2.













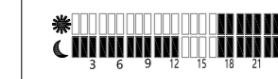
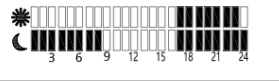

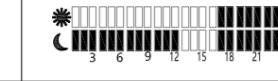
- For better understanding, here is a example: Monday, 00:00 to 08:00 Comfort mode, 08:00 to 17:00 Anti-freeze mode, 17:00 to 21:00 ECO mode, 21:00 to 24:00 Comfort mode, then setting as below:

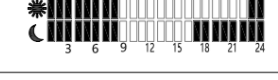
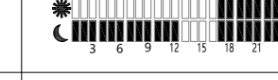
- In P2 mode, press and hold button **M** for 3 seconds,  flash, press **+** button to select , press **OK** button to confirm.
-  flash, press **+** button to select 8, press **OK** button to confirm, Comfort, ECO and anti-freeze light flash, press **+** button to select comfort , press **OK** button to confirm;
-  flash, press **+** button to select 17, press **OK** button to confirm, Comfort, ECO and anti-freeze light flash, press **+** button to select anti-freeze , press **OK** button to confirm;
-  flash, press **+** button to select 21, press **OK** button to confirm, Comfort, ECO and anti-freeze light flash, press **+** button to select ECO , press **OK** button to confirm;

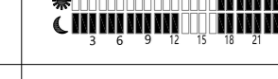
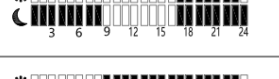
- **H** flash, press **+** button to select 24, press **OK** button to confirm, Comfort, ECO and anti-freeze light flash, press **+** button to select comfort , press **OK** button to confirm;
- **d** flash, select **d2**, continue to set Tuesday. Repeat the setting until 7 days all are set.

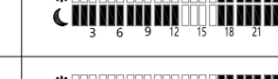
- P1, P2 and P3 default setting as below:

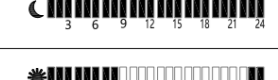
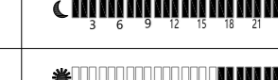
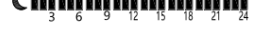
Comfort: , ECO: , Anti-freeze: 

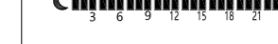
	P1	P2	P3
d1			
d2			
d3			
d4			
d5			
d6			
d7			

7. Open window function

- Default setting is off.
- Press button **M** and select open window, display **OF** flash, press **+** or **-** button to set "On" or "OF", press **OK** button to confirm.
- After setting, it will go back to the previous mode. For example when it is running comfort mode, after setting open window, it go back to comfort mode.
- When open window function start running, the heater enter into anti-freeze mode, and display show **F0**.
- Open window function description:

If you open a window widely in the space where the heater is located and the temperature drop more than 2°C in 5 minutes, the sensor will detect the sharp drop in temperature. The heater will enter into anti-freeze mode and display show **F0**. The heater will come back to the previous mode if the room temperature raise more than 2°C in 5 minutes. However you can manually restart the heater by pressing  button, **F0** disappears of the display.



8. WiFi connection

- Use Tuya Smart or Smart Life APP for iOS and Android. Search and download “Tuya Smart” or “Smart Life” APP from Apple store or Google play.

- By connecting your heater with the iOS/Android device you can do the following:

- Set on/Stand by
- Set comfort, ECO, anti-freeze, week program and device control mode
- Set temperature of Comfort/ECO mode
- Set 24 hours timer
- Set week program - Program data is match to P2 program on product.
- Set open window function on/off
- Set temperature correction
- Set group(put heaters in one zone)
- Share the heater to other user

- How to connect WiFi:

- Before connecting, please make sure the WiFi and bluetooth function is open on your phone.
- There are two ways to connect WiFi: SC mode and AP mode. Usually we recommend to connect WiFi by SC mode, but if EZ mode doesn't connect successfully, you can try AP mode again.
- Press WiFi button, display show  and WiFi light flash, open Tuya Smart APP or Smart Lift APP, it will ask you if you want to add a new device, then follow it to add.
- If need connect by AP mode, press and hold WiFi button for 3 seconds, display show  and WiFi light flash, open Tuya Smart APP or Smart Lift APP and follow it to connect.

- How to dis-connect WiFi:

- Press and hold WiFi button for 3 seconds to delete WiFi connection.
- Delete the device on APP also is ok.

9. Factory resetting

- In standby mode, turn off the heater by the power switch, then turn on the heater by power switch. After turn on, within 10 seconds, press and hold button **+** and **-** for 3 seconds at the same time to reset.

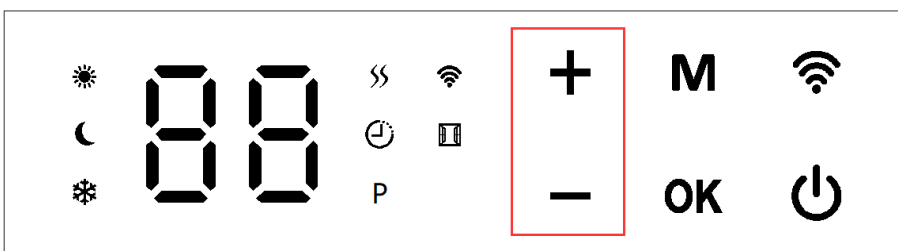

Maintenance

- ALWAYS isolate the unit from the power supply and let it cool before any maintenance.
- Clean the unit at least once a year with a vacuum cleaner to remove any dust from the heap.
- Clean the outside of the device by wiping with a damp cloth and drying with a dry cloth. Never immerse the appliance in water and never allow water to enter the unit.

Recycling

Processing of electric and electronic equipment at the end of their service life (applicable in member countries of the European Union and other European countries operating a selective waste collection system). This symbol, affixed to the product or its packaging, indicates that the product must not be processed with household waste. It must be brought to an electric and electronic waste collection point for recycling and disposal. By ensuring the appropriate disposal of this product you also help in preventing potentially negative consequences for the environment and human health. The recycling of materials helps preserve our natural resources. For further information regarding the recycling of this product, please contact your municipality, local waste disposal centre or the store where the product was purchased.



Information requirements for electric local space heaters					
Model identifier(s): EODT060A/ EODT060W					
Item	Symbol	Value	Unit	Item	Unit
Heat output			Type of heat input, for electric storage local space heaters only (select one)		
Nominal heat output	P_{nom}	1,0	kW	manual heat charge control, with integrated thermostat	[no]
Minimum heat output (indicative)	P_{min}	NA	kW	manual heat charge control with room and/or outdoor temperature feedback	[no]
Maximum continuous heat output	$P_{max,c}$	1,0	kW	electronic heat charge control with room and/or outdoor temperature feedback	[no]
Auxiliary electricity consumption				fan assisted heat output	[no]
At nominal heat output	e_{lmax}	0	kW	Type of heat output/room temperature control (select one)	
At minimum heat output	e_{lmin}	0	kW	single stage heat output and no room temperature control	[no]
In standby mode	e_{lSB}	Pending	kW	Two or more manual stages, no room temperature control	[no]
				with mechanic thermostat room temperature control	[no]
				with electronic room temperature control	[no]
				electronic room temperature control plus day timer	[no]
				electronic room temperature control plus week timer	[yes]
				Other control options (multiple selections possible)	
				room temperature control, with presence detection	[no]
				room temperature control, with open window detection	[yes]
				with distance control option	[yes]
				with adaptive start control	[no]
				with working time limitation	[no]
				with black bulb sensor	[no]
Contact details	Atay Global Ltd. Unit 6 Weybridge Farm, Stambourne Road, Great Yeldham, Essex, CO9 4RB				

Information requirements for electric local space heaters					
Model identifier(s): EODT082A/ EODT082W					
Item	Symbol	Value	Unit	Item	Unit
Heat output			Type of heat input, for electric storage local space heaters only (select one)		
Nominal heat output	P_{nom}	1,5	kW	manual heat charge control, with integrated thermostat	[no]
Minimum heat output (indicative)	P_{min}	NA	kW	manual heat charge control with room and/or outdoor temperature feedback	[no]
Maximum continuous heat output	$P_{max,c}$	1,5	kW	electronic heat charge control with room and/or outdoor temperature feedback	[no]
Auxiliary electricity consumption			fan assisted heat output		
At nominal heat output	e_{lmax}	0	kW	Type of heat output/room temperature control (select one)	
At minimum heat output	e_{lmin}	0	kW	single stage heat output and no room temperature control	[no]
In standby mode	e_{lSB}	Pending	kW	Two or more manual stages, no room temperature control	[no]
			with mechanic thermostat room temperature control		
			with electronic room temperature control		
			electronic room temperature control plus day timer		
			electronic room temperature control plus week timer		
			Other control options (multiple selections possible)		
			room temperature control, with presence detection		
			room temperature control, with open window detection		
			with distance control option		
			with adaptive start control		
			with working time limitation		
			with black bulb sensor		
Contact details	Atay Global Ltd. Unit 6 Weybridge Farm, Stambourne Road, Great Yeldham, Essex, CO9 4RB				

Information requirements for electric local space heaters					
Model identifier(s): EODT099A/ EODT099W					
Item	Symbol	Value	Unit	Item	Unit
Heat output			Type of heat input, for electric storage local space heaters only (select one)		
Nominal heat output	P_{nom}	2,0	kW	manual heat charge control, with integrated thermostat	[no]
Minimum heat output (indicative)	P_{min}	NA	kW	manual heat charge control with room and/or outdoor temperature feedback	[no]
Maximum continuous heat output	$P_{max,c}$	2,0	kW	electronic heat charge control with room and/or outdoor temperature feedback	[no]
Auxiliary electricity consumption			fan assisted heat output		
At nominal heat output	e_{lmax}	0	kW	Type of heat output/room temperature control (select one)	
At minimum heat output	e_{lmin}	0	kW	single stage heat output and no room temperature control	[no]
In standby mode	e_{lSB}	Pending	kW	Two or more manual stages, no room temperature control	[no]
				with mechanic thermostat room temperature control	[no]
				with electronic room temperature control	[no]
				electronic room temperature control plus day timer	[no]
				electronic room temperature control plus week timer	[yes]
				Other control options (multiple selections possible)	
				room temperature control, with presence detection	[no]
				room temperature control, with open window detection	[yes]
				with distance control option	[yes]
				with adaptive start control	[no]
				with working time limitation	[no]
				with black bulb sensor	[no]
Contact details	Atay Global Ltd. Unit 6 Weybridge Farm, Stambourne Road, Great Yeldham, Essex, CO9 4RB				