



## MANUAL INSTRUCTIONS

# SERRE Electric Radiator



This instruction manual applies to the following products:  
ESRR048W/ESRR048A, ESRR064W/ESRR064A, ESRR080W/ESRR080A

## Important!

- NEVER TOUCH YOUR HEATER OR ITS CASING WITH WET HANDS!
- DO NOT COVER THE HEATER!
- When using any electrical device, be sure to follow basic safety precautions, such as the instructions in this instruction manual.

## General safety instructions

- **PLEASE READ THE FOLLOWING INSTRUCTIONS CAREFULLY BEFORE USING THE APPLIANCE.**
- Read this manual carefully before using the device.
- Check that the mains voltage corresponds to that of the device.
- Do not use the appliance if the cable is damaged.
- Keep this unit and its cord away from sources of heat, sharp objects, or anything that could damage it.
- If the supply cord is damaged, it must be replaced by the manufacturer, its service agent or similarly qualified persons in order to avoid a hazard.
- Before connecting the unit to the power supply, make sure that the switch is “Off”.
- Turn off the power and isolate it from the power supply before cleaning or before working.

- Always place the unit on a stable, level surface and use it in an upright position.
- Do not operate the unit in areas where gasoline, paint or other flammable liquids may be used or stored.
- For indoor use only.
- To prevent a fire, do not block the air inlet and outlet in any way.
- Do not touch hot surfaces.
- Do not insert or allow foreign objects to enter any ventilation or exhaust opening as this will cause electric shock or fire and damage the unit.
- Always make sure your hands are dry before adjusting any switch or touching the unit.
- This appliance can be used by children aged from 8 years and above and persons with reduced physical, sensory or mental capabilities or lack of experience and knowledge if they have been given supervision or instruction concerning use of the appliance in a safe way and understand the hazards involved. Children shall not play with the appliance. Cleaning and user maintenance shall not be made by children without supervision.
- Children of less than 3 years should be kept away unless continuously supervised.
- Children aged from 3 years and less than 8 years shall only switch on/off the appliance provided that it has been placed or installed in its intended normal operating position and they have been given

supervision or instruction concerning use of the appliance in a safe way and understand the hazards involved. Children aged from 3 years and less than 8 years shall not plug in, regulate and clean the appliance or perform user maintenance.

- **CAUTION — Some parts of this product can become very hot and cause burns. Particular attention has to be given where children and vulnerable people are present.**
- The main cause of overheating is due to dust deposits or residues in the unit. Make sure these foreign bodies are removed regularly. Isolate the unit from the network and clean it by vacuuming the air inlet and the grilles.
- The heater must not be located immediately below a socket-outlet.
- When the product is used as fixed heater: The heater is to be installed so that switches and other controls cannot be touched by a person in the bath or shower.







- **WARNING: In order to avoid overheating, do not cover the heater.**
- For the information of installation and maintenance, refer to the “INSTALLATION” section and “MAINTENANCE” section.
- Do not use the unit with a timer, timer, separate remote control system, or any other device that automatically turns on the unit, as there is a risk of fire if the unit is covered or placed incorrectly.
- **WARNING!** In order to avoid any danger due to the accidental reset of the thermal circuit breaker, the device must not be powered via

an external switch, such as a timer, or be connected to a circuit which is regularly switched on and off by the electricity supplier.

- The appliance must not be disposed of with household waste; it must be brought to a local center for the recovery and recycling of electrical appliances.
- When installing the heater on its support, you must ensure that the electrical cable does not come into contact with the metal casing of the heater.

## Description of symbols

	Complies with European regulations applying to the product.
	<b>WARNING:</b> In order to avoid overheating, do not cover the heater.
	Electrical products should not be disposed of with household waste. Please recycle them at the collection points provided for this purpose. Contact the local authorities or your dealer for recycling advice.
	<b>CAUTION</b> The device may be hot, do not touch it without taking precautions.

The use of symbols in this manual is intended to draw attention to possible risks. The safety symbols and explanations that accompany them must be fully understood. The warnings themselves do not eliminate the risks and cannot replace the correct measures of accident prevention.

## Technical characteristics

- LED display, touch screen
- Temperature setting: 5 ~35°C
- 24 hours timer
- With WiFi control
- Open window function

Code	Names	Voltage	Power	IP	Class	Height(mm)	Length(mm)
ESRR048W	SERRE ALUMINIUM PANEL HEATER WHITE WIFI	230 V~ 50 Hz	1000W	IP24	Class I	580	480
ESRR064W	SERRE ALUMINIUM PANEL HEATER WHITE WIFI	230 V~ 50 Hz	1500W	IP24	Class I	580	640
ESRR080W	SERRE ALUMINIUM PANEL HEATER WHITE WIFI	230 V~ 50 Hz	2000W	IP24	Class I	580	800
ESRR048A	SERRE ALUMINIUM PANEL HEATER ANTHRACITE WIFI	230 V~ 50 Hz	1000W	IP24	Class I	580	480
ESRR064A	SERRE ALUMINIUM PANEL HEATER ANTHRACITE WIFI	230 V~ 50 Hz	1500W	IP24	Class I	580	640
ESRR080A	SERRE ALUMINIUM PANEL HEATER ANTHRACITE WIFI	230 V~ 50 Hz	2000W	IP24	Class I	580	800

## Wall Mounted Installation

**IMPORTANT!** Make sure that there is no electrical wiring or other installation (water pipe for example) near the locations where the holes will be drilled. Be sure to fix the unit vertically and firmly to the wall.

This appliance is intended for indoor installation and use only.

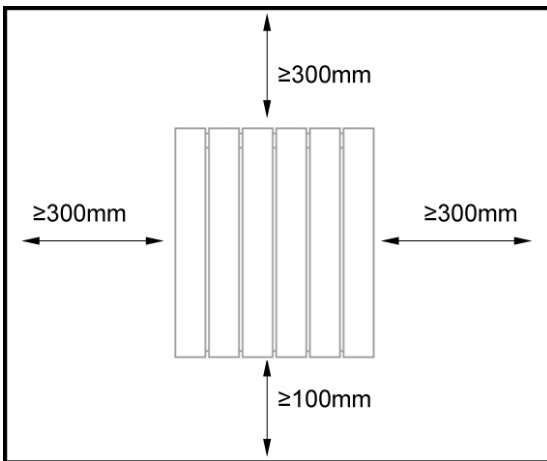

Fig 1



Fig 2

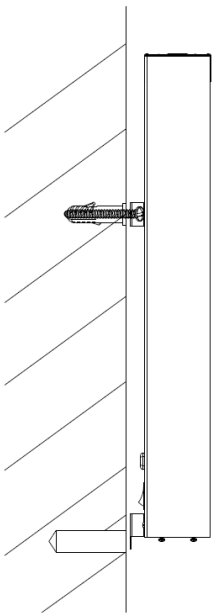

Fig 3

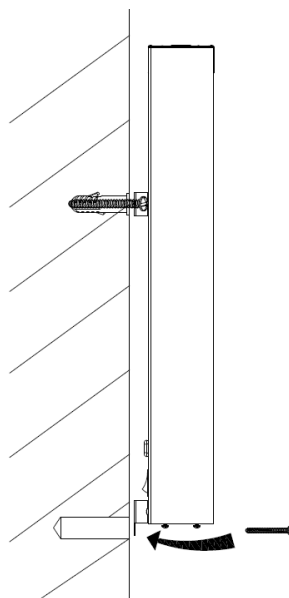

Fig 4

1. Be sure to keep the distance between the heater and floor, wall at least 30cm as picture (Fig 1).
2. Use drill dimension paper to drill top two holes( $\Phi 8$ ) on the wall and put the expansion screws in the holes as picture (Fig 2).

3. The hook racks are pre-assembled on the back of the heater. Hang the top two hook racks on the screws as picture (Fig 3).

Mark the two bottom hook racks' position on the wall and take away the heater, then drill bottom two holes(Φ8) on the wall and put expansion screw's plastic cover in the holes as picture (Fig 3).

4. Hang the heater on the wall and put the expansion screws in the bottom two holes as picture (Fig 4).

**CAUTION:** Before starting the appliance, make sure it's Wall-mounted correctly. If it's not parallel to the floor, technical problems can occur.

## Using

### Control panel

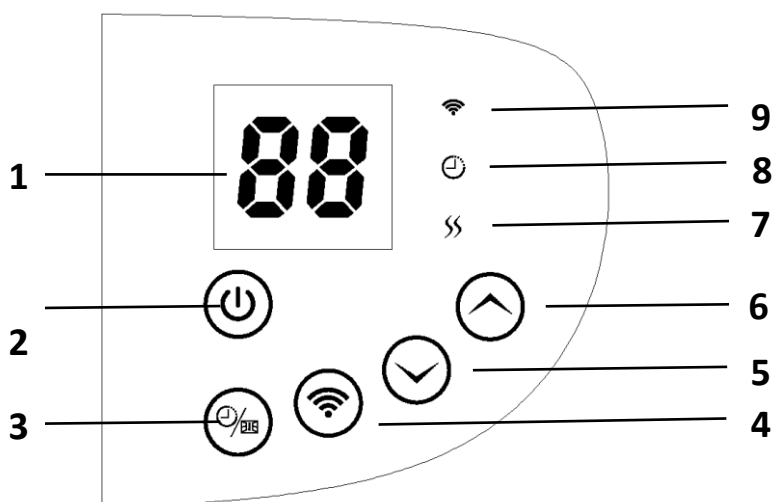

1	2	3	4	5	6	7	8	9
Display	On/Off button	Timer/Open window button	WiFi button	Decrease button	Increase button	Power indicator light	Timer indicator light	WiFi indicator light

### WiFi connection

Use TuyaSmart or Smart Life APP for iOS and Android. Search and download “TuyaSmart” or “Smart Life” APP from Apple store or Google play.

By connecting your heater with the iOS/Android device you can do the following:

- Set on/off
- Set running modes:
  1. Comfort: “HO” and setting temperature will be displayed by 3 seconds cycle.
  2. ECO: “EC” and setting temperature will be displayed by 3 seconds cycle.
  3. Anti freeze: “AF” will be displayed.



4. Week program: Running according to your program setting.
5. Device control: When you set on product, the APP will change to device control mode.
  - Set 24 hours timer
  - Set open window function on/off
  - Set week programs' running date, time and temperature.
  - Set Temperature calibration.
  - Set group(put heaters in one zone)
  - Share the heater to other user.

### Connect WiFi:

- Factory default WiFi setting is WiFi indicator light is off.
- Press WiFi button to connect WiFi, and the display will show .
- Open Tuya APP, and make sure the bluetooth function is opened on your phone, then the Tuya APP will show that there is a new device, do you want to add. Follow the APP to add. After add successfully, the WiFi indicator light will keep on the display.

### Delete WiFi:

- If the device is connected to WiFi, press and hold WiFi button for 3 seconds to delete WiFi, or you can remove the device from Tuya APP.



## Operations

### Turn on:







- Plug in and switch on the heater, the heater will enter into standby mode, and show "OF" on display.  
Press  button to turn on the heater, and show factory default setting temperature 22°C on display

### Temperature setting:





- Temperature setting range is 5~35°C.
- Default temperature setting is 22°C.

- Press  or  button to set temperature, the temperature will increase or decrease by 1°C after each pressing. It will show setting temperature on display after setting.

## Timer:

- Press  button, “00” flash on display, then press  or  button to set timer. Each pressing is 1 hour. Press  button to save setting, or wait 15 seconds to save automatically. Timer indicator light will keep on red after setting.
- Timer set range is 0 to 24 hours.
- Press  button again to modify or cancel timer setting.
- After timer close, the heater will enter into standby mode, and press  button to turn on the heater.

## Open window function

- The heater has an open window function.
- Default setting of open window function is closed.
- Press and hold  button for 5 seconds, display show “F0”, then press  button to open open window function, display show “ON”, and press  button to close open window function, display show “OF”, then press  button to save setting, or wait 15 seconds to save automatically.
- Open window function description:
  1. If you open a window widely in the space where the heater is located and the temperature drop 2 °C or more than 2°C in two minutes, a sensor will detect the sharp drop in temperature. The heater will switch out automatically and show “F0” in display.
  2. The heater will be reignited automatically after 10 minutes. However you can manually relight the heater before the 10 minutes end by pressing . The icon “F0” disappears and show previous operation mode.

## Resetting the heater

- Turn off the heater's main switch.
- Press and hold  while you turn on the heater's main switch.

## Maintenance

- ALWAYS isolate the unit from the power supply and let it cool before any maintenance.
- Clean the unit at least once a year with a vacuum cleaner to remove any dust from the heap.
- Clean the outside of the device by wiping with a damp cloth and drying with a dry cloth. Never immerse the appliance in water and never allow water to enter the unit.

## Recycling

Processing of electric and electronic equipment at the end of their service life (applicable in member countries of the European Union and other European countries operating a selective waste collection system). This symbol, affixed to the product or its packaging, indicates that the product must not be processed with household waste. It must be brought to an electric and electronic waste collection point for recycling and disposal. By ensuring the appropriate disposal of this product you also help in preventing potentially negative consequences for the environment and human health. The recycling of materials helps preserve our natural resources. For further information regarding the recycling of this product, please contact your municipality, local waste disposal centre or the store where the product was purchased.



**Information requirement for the electric local space heaters**

Reference (s) of the model : ESRR048W/ESRR048A					
Item	Symbol	Value	Unit	Item	Unit
<b>Heat output</b>				<b>Type of heat input, for electric storage local space heaters only (select one)</b>	
Nominal heat output	$P_{nom}$	1.0	kW	manual heat charge control, with integrated thermostat	NO
Minimum heat output (indicative)	$P_{min}$	N/A	kW	manual heat charge control with room and/or outdoor temperature feedback	NO
Maximum continuous heat output	$P_{max,c}$	1.0	kW	electronic heat charge control with room and/or outdoor temperature feedback	NO
<b>Auxiliary electricity consumption</b>				fan assisted heat output	
At nominal heat output	$el_{max}$	N/A	kW	<b>Type of heat output/room temperature control (select one)</b>	
At minimum heat output	$el_{min}$	N/A	kW	single stage heat output and no room temperature control	NO
In standby mode	$el_{SB}$	0.00081	kW	Two or more manual stages, no room temperature control	NO
				with mechanic thermostat room temperature control	NO
				with electronic room temperature control	NO
				electronic room temperature control plus day timer	NO
				electronic room temperature control plus week timer	YES
				<b>Other control options (multiple selections possible)</b>	
				room temperature control, with presence detection	NO
				room temperature control, with open window detection	YES
				with distance control option	YES
				with adaptive start control	NO
				with working time limitation	NO
				with black bulb sensor	NO
Contact details	Atay Global Ltd. Unit 6 Weybridge Farm, Stambourne Road, Great Yeldham, Essex, CO9 4RB				

Reference (s) of the model : ESRR064W/ESRR064A					
Item	Symbol	Value	Unit	Item	Unit
<b>Heat output</b>				<b>Type of heat input, for electric storage local space heaters only (select one)</b>	
Nominal heat output	$P_{nom}$	1.5	kW	manual heat charge control, with integrated thermostat	NO
Minimum heat output (indicative)	$P_{min}$	N/A	kW	manual heat charge control with room and/or outdoor temperature feedback	NO
Maximum continuous heat output	$P_{max,c}$	1.5	kW	electronic heat charge control with room and/or outdoor temperature feedback	NO
<b>Auxiliary electricity consumption</b>				fan assisted heat output	
At nominal heat output	$eI_{max}$	N/A	kW	<b>Type of heat output/room temperature control (select one)</b>	
At minimum heat output	$eI_{min}$	N/A	kW	single stage heat output and no room temperature control	NO
In standby mode	$eI_{SB}$	0.00081	kW	Two or more manual stages, no room temperature control	NO
				with mechanic thermostat room temperature control	NO
				with electronic room temperature control	NO
				electronic room temperature control plus day timer	NO
				electronic room temperature control plus week timer	YES
				<b>Other control options (multiple selections possible)</b>	
				room temperature control, with presence detection	NO
				room temperature control, with open window detection	YES
				with distance control option	YES
				with adaptive start control	NO
				with working time limitation	NO
				with black bulb sensor	NO
Contact details	Atay Global Ltd. Unit 6 Weybridge Farm, Stambourne Road, Great Yeldham, Essex, CO9 4RB				

Reference (s) of the model : ESRR080W/ESRR080A					
Item	Symbol	Value	Unit	Item	Unit
<b>Heat output</b>				<b>Type of heat input, for electric storage local space heaters only (select one)</b>	
Nominal heat output	$P_{nom}$	2.0	kW	manual heat charge control, with integrated thermostat	NO
Minimum heat output (indicative)	$P_{min}$	N/A	kW	manual heat charge control with room and/or outdoor temperature feedback	NO
Maximum continuous heat output	$P_{max,c}$	2.0	kW	electronic heat charge control with room and/or outdoor temperature feedback	NO
<b>Auxiliary electricity consumption</b>				fan assisted heat output	
At nominal heat output	$eI_{max}$	N/A	kW	<b>Type of heat output/room temperature control (select one)</b>	
At minimum heat output	$eI_{min}$	N/A	kW	single stage heat output and no room temperature control	NO
In standby mode	$eI_{SB}$	0.00081	kW	Two or more manual stages, no room temperature control	NO
				with mechanic thermostat room temperature control	NO
				with electronic room temperature control	NO
				electronic room temperature control plus day timer	NO
				electronic room temperature control plus week timer	YES
				<b>Other control options (multiple selections possible)</b>	
				room temperature control, with presence detection	NO
				room temperature control, with open window detection	YES
				with distance control option	YES
				with adaptive start control	NO
				with working time limitation	NO
				with black bulb sensor	NO
Contact details	Atay Global Ltd. Unit 6 Weybridge Farm, Stambourne Road, Great Yeldham, Essex, CO9 4RB				