

# INSTALLATION INSTRUCTIONS AND USER GUIDE



eco fluid



## INERTIA ELECTRIC RADIATOR

RF3P	RF3F	RF3E
RF4P	RF4F	RF4E
RF5P	RF5F	RF5E
RF6P	RF6F	RF6E
RF8P	RF8F	RF8E
RF10P	RF10F	RF10E
RF12P	RF12F	RF12E

Please read these instructions before installing or  
using this appliance for the first time

**Gabarrón**  
Manufacturing Excellence

# Inertia Electric Radiators

## INSTALLATION INSTRUCTIONS

### 1.- WARNING

- The warranty of the heater will not cover any damage caused by non observance of any of these instructions.
- This guide must be kept and given to any new owner.
- Please check that the voltage in the rating label fits the power supply.
- Any reinstallation should be carried out by trained personnel.
- The use of these heaters is forbidden in any area where there is a presence of gases, explosives or inflammable objects.
- DO NOT USE THIS HEATER TO DRY CLOTHES.
- The surfaces of this heater can be hot, so young children should not be left unsupervised in the vicinity of the heater.
- Children should be supervised to ensure they do not play with the appliance.
- Neither the connecting cable nor any other object must come into contact with the hot unit.
- Do not cover this heater at any time.
- The air outlet at the top of the thermal radiator and the air inlet at the bottom are provided to ensure the most efficient operation of the appliance. They also protect the heater from overheating; therefore, it is essential that at no time are they covered.
- This heater should be switched off at the isolating switch before any repair work is carried out.
- The thermal radiator should not be installed just below an electrical socket.
- The appliance must be installed in such a way that it is impossible for anyone using a bath or shower, to touch the controls.
- The installation must be carried out in accordance with the current electrical regulations.
- The heater is fitted with a flexible cable size 3 x 1.00 mm<sup>2</sup> for electrical connection. It may be used to connect the heater to the fixed wiring of the premises through a suitable connection box positioned adjacent to the heater.
- The supply circuit to the heater must incorporate a double pole isolating switch having a contact separation of at least 3 mm.
- If the flexible power cable for this unit is damaged, it may only be replaced by a repair workshop recognised by the manufacturer, as special tools are necessary.
- This appliance is not intended for use by persons with reduced physical, sensory or mental capabilities, or lack of experience and knowledge, unless they have been given supervision or instruction concerning the use of the appliance by a person responsible for their safety.
- This appliance must be earthed.
- All models are supplied with an electrical interrupt cut-out. This will switch off the heater if, for any reason, it overheats. Should the cut-out operate, turn the heater off and remove the cause for the overheating. The cut-out will be reset automatically.
- The presence of air particles of smoke, dust and other pollutants could, in time, discolour the walls and surfaces around the heater.
- This heater is filled with a precise quantity of special oil. Repairs requiring the opening of the oil container are only to be made by the manufacturer or his service agent who should be contacted if there is an oil leakage.
- Regulations concerning the disposal of oil when scrapping the appliance have to be followed.

MODELS	<i>RF3P</i>	<i>RF4P</i>	<i>RF5P</i>	<i>RF6P</i>	<i>RF8P</i>	<i>RF10P</i>	<i>RF12P</i>
	<i>RF3F</i> <i>RF3E</i>	<i>RF4F</i> <i>RF4E</i>	<i>RF5F</i> <i>RF5E</i>	<i>RF6F</i> <i>RF6E</i>	<i>RF8F</i> <i>RF8E</i>	<i>RF10F</i> <i>RF10E</i>	<i>RF12F</i> <i>RF12E</i>
MODULES	3	4	5	6	8	10	12
W (cm)	33.5	41.5	49.5	57.5	73.5	89.5	105.5
D (cm)	10 plus 2 cm separated from the wall						
H (cm)	58						
WEIGHT (kg)	7,5	9,5	11,5	13,5	17,5	21,5	25,5
VOLTAGE	220-240V~						
INPUT (W)	375	500	625	750	1000	1250	1500

# Inertia Electric Radiators

## 2.- INSTRUCTIONS ON INSTALLATION

- Open the carton at the indicated side. The screws are in the accessories bag. Turn the carton upside down to allow the heater to stand. Check that it is the correct model and that it is in good condition.
- To obtain optimum performances it is necessary to maintain a minimum clearance of 15 cm between the radiator and any inflammable material as furniture, curtains etc. See figure.

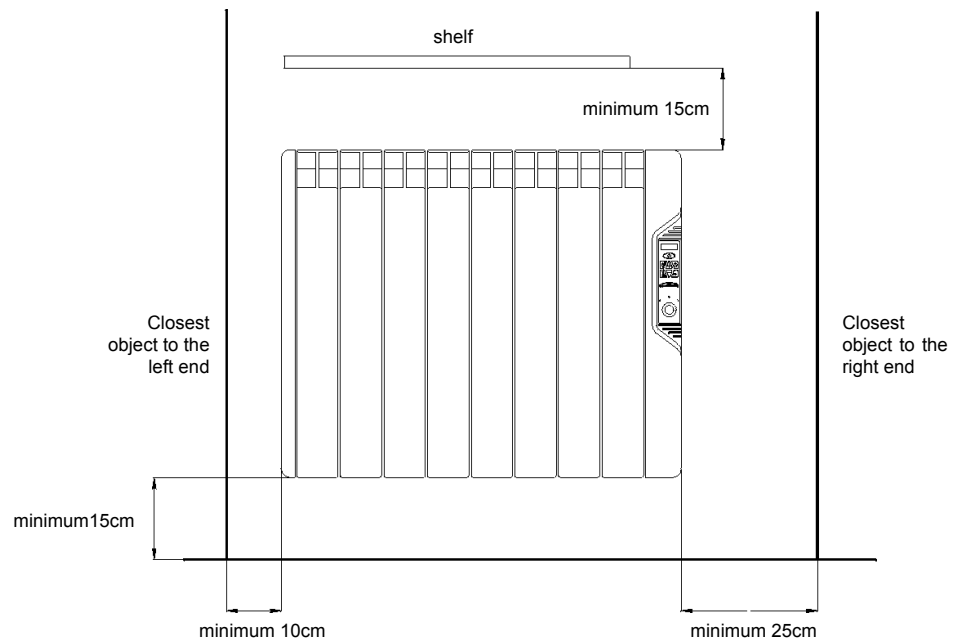

Position and fix the brackets at the correct distance from the floor and hang the unit on the hooks of the brackets. and mark the wall. Use the polystyrene packaging to level the heater and protect the floor.

Use the heater as a template and mark the fixing points on the wall using a pencil through the two fixing holes in the square brackets.

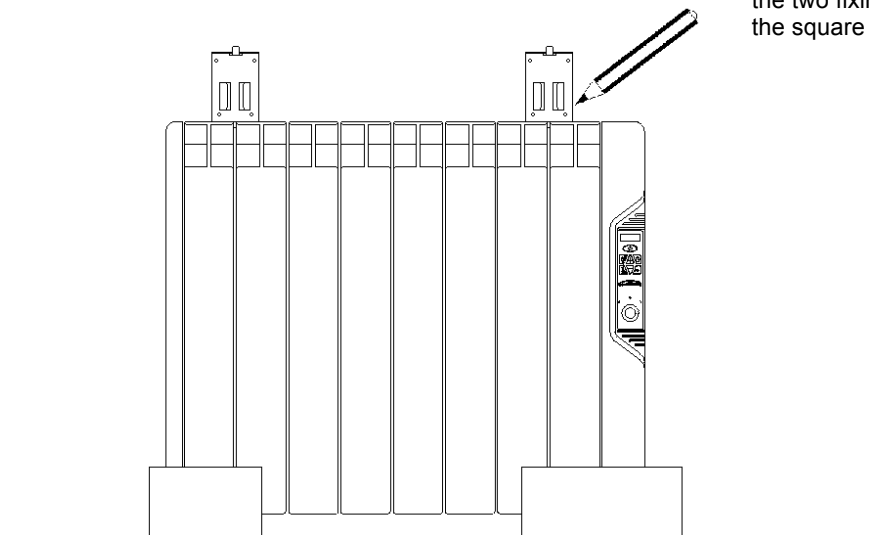

- The studs and screws are in the accessories bag.
- Hung the unit on the hooks of the brackets.
- By turning the screw the metallic square will go downwards, retaining the heater. Repeat this on the other bracket.

# Inertia Electric Radiators

## 3.- USING THE THERMAL RADIATOR

### ELECTRONICS MODELS RFP

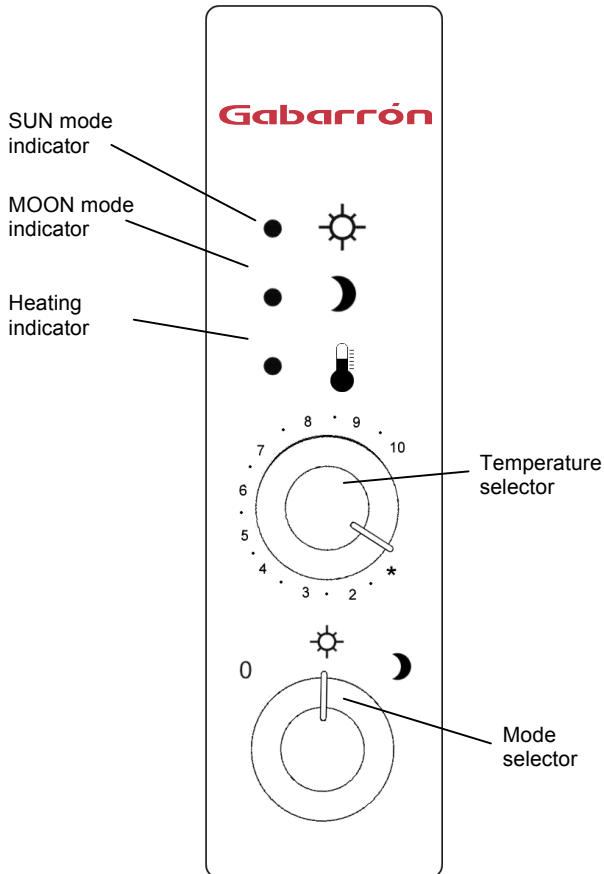

Operation in electronic models is controlled by means of two rotary knobs.

It is possible to regulate the temperature level with accuracy by means of the **temperature selector**. The heating indicator will be lit when the heater is consuming energy. When this dial is set in \* position the heater is in frost protection mode, at this stage if the room temperature drops below 3°C the heater will connect itself automatically.

There are three selectable positions with the **mode selector** dial:

- 0 : The heater is switched off permanently. No frost protection mode here.
- ☀ : SUN mode on, the heater maintains the set temperature with the temperature selector dial.
- ☾ : Moon mode on, the heater maintains a temperature 3°C lower than the one set with the temperature selector dial.

# Inertia Electric Radiators

## MODELOS RF-F DIGITAL CONTROL

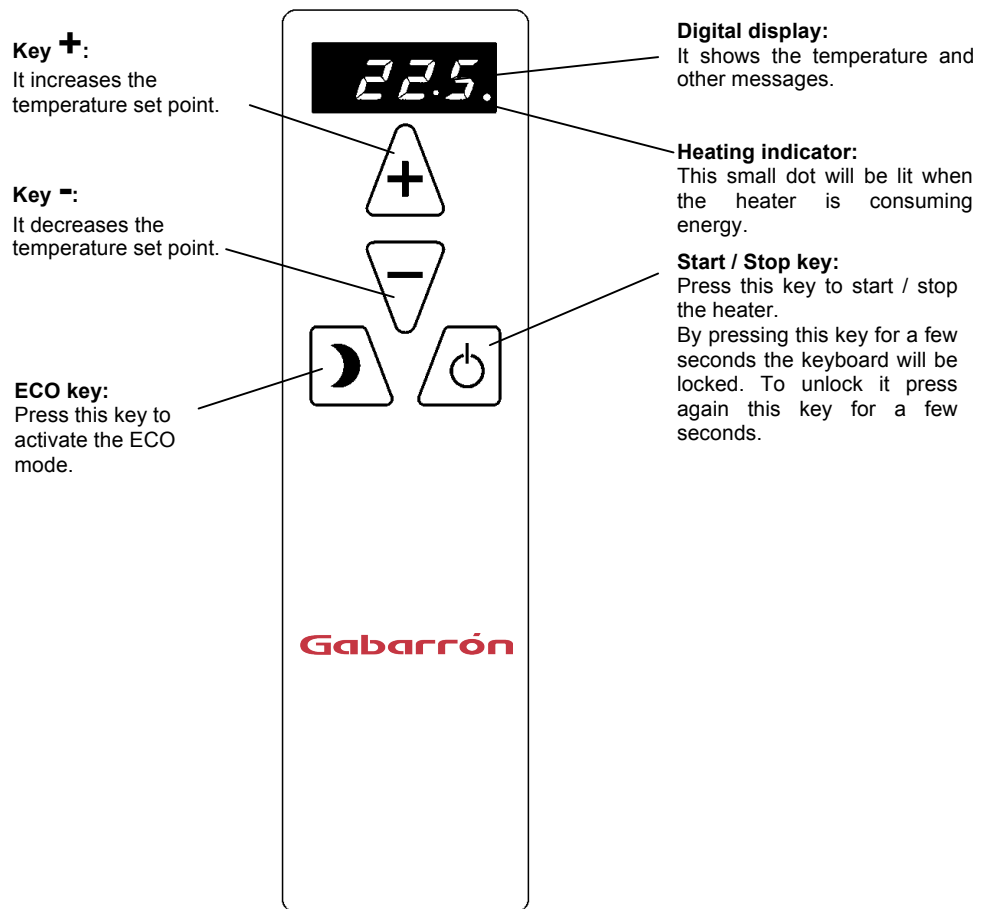

### START / STOP

Press the key  to start / stop the heater. Once the heater is started the display will show the room temperature. When the heater is stopped a small dot in the display will advise that the heater is in stand-by. To switch it off completely unplug the cable from the supply circuit or operate the double pole switch at the consumer unit.

### SELECTING THE ROOM TEMPERATURE

The digital models RFS-F have a built-in ambient thermostat with a sensibility of 0.1°C. It is possible to set the room temperature with an accuracy of 0.5°C.

Set the room temperature by means of the **+** and **-** keys. The set point will be shown blinking, then it will be automatically validated and the display will show the existing room temperature. An small dot will be lit when the heater is consuming energy.

### ECO MODE:

Select the ECO mode by pressing the  key. The display will show **E c o** and the room temperature will be reduced 3°C.



*Note: It is possible to modify the set back value from 3°C to a different one. Press the  key four seconds and the display will show **3.0** as the factory default value. Increase or decrease the value using the **+** and **-** keys. The new set back value for ECO mode will be stored automatically in a few seconds.*

### FROST PROTECTION MODE:

With this mode on, if the room temperature drops below 5°C the heater will connect itself automatically.

Press the **-** key to decrease the room temperature set point until the display shows **HHH**.

### KEYBOARD LOCK

Press the  key more than six seconds and the keyboard will be locked. The display will show **[ - ]** and the controller will keep on working internally. To unlock the keyboard press again the  key more than four seconds.

# Inertia Electric Radiators



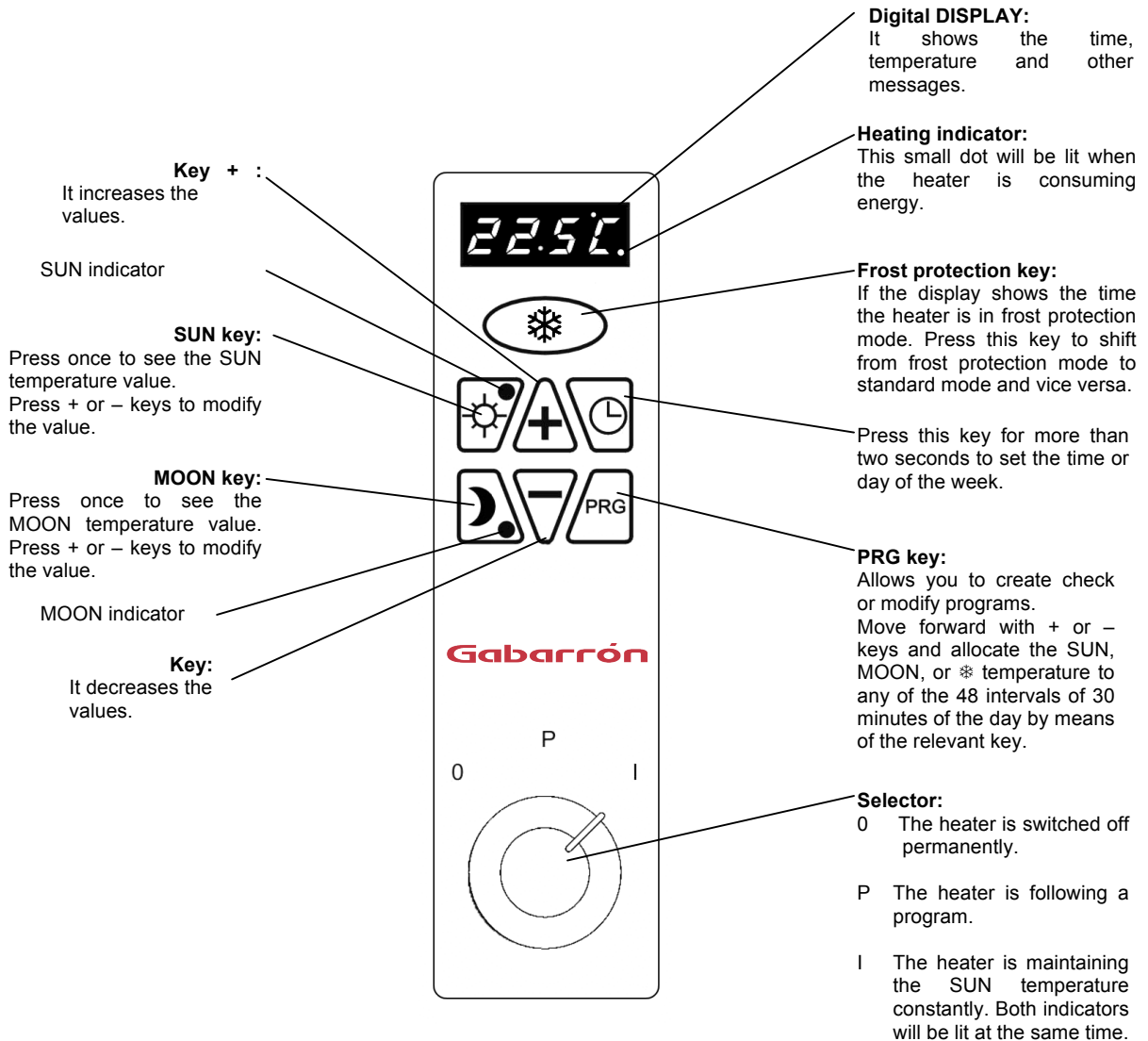

## DIGITALS MODELS RFE



Digital models have built in an electronic thermostat with a sensibility of 0.1 °C. It is possible to set temperatures with an accuracy of 0.5°C.

The daily or weekly programmer (selectable) allows you to allocate three different temperature levels to any of the 48 intervals of 30 minutes of the day.

### SWITCHING ON THE HEATER AND SETTING THE TIME

Turn the mode selector dial to **P** position and press the  key more than two seconds. The display will show the time intermittently. Set the minutes by pressing **+** and **-** keys and press the . Set the hours the same way. Press once more the  key to store the time. If at any time it is necessary to set the time press the  key and repeat the above steps.

### FROST PROTECTION MODE ❄:

With this mode on, if the room temperature drops below 3°C the heater will connect itself automatically.

If the display shows the time the heater is in frost protection mode. Press the ❄ key to shift from frost protection mode (time is shown in the display) to standard mode (temperature is shown in the display) and vice versa.

### SELECTOR "O", "P", "I".

Position "0" : The heater is switched off permanently. The display is switched off.

Position "P" : The heater is following a program. It will maintain the SUN, MOON or ❄ temperatures as per the introduced program. At this position if the display shows the time the heater is frost protection mode.

Position "I" : The heater is maintaining the SUN temperature constantly both luminous indicators SUN and MOON will be lit. This could be useful when SUN temperature is required and we do not want to modify the program. At this position if the display shows the time the heater is in frost protection mode. Press the ❄ key to shift from frost protection mode (time is shown in the display) to standard mode (temperature is shown in the display) and vice versa.

# Inertia Electric Radiators

---

## SUN, MOON AND ❄️ TEMPERATURES

The electronic programmer is able to handle three temperature levels during the 24h of the day.

Press the  key to set the SUN temperature. The display will show the SUN temperature value blinking.

Set the SUN temperature value by means of the **+** **o** **-** keys and press the  key to store the value. If the display shows the time the heater is in frost protection mode. Press the ❄️ key to shift from frost protection mode (time is shown in the display) to standard mode (temperature is shown in the display) and vice versa.

Repeat the above steps with the key  to set the MOON temperature.



The ❄️ temperature level is 3°C and it is a fix value. This temperature level can be used as off selection when setting the temperatures during certain times of the day.



SUN, MOON, or ❄️ temperatures can be allocated to any of the 48 intervals of 30 minutes of the day.

# Inertia Electric Radiators

## DAILY PROGRAMMES

It is basic to visualize the day split into 48 intervals of 30 minutes each; SUN, MOON, or ❄️ temperatures can be allocated to any of them. The default settings include daily mode so that the heater will repeat the program every day. If different programmes are required along a week, please see the next step WEEKLY PROGRAMMES. To check a programme or to make a new one follow these steps:

Press the **PRG** key and the display will show **00:00** intermittently. Press one of the three keys   ❄️ to allocate SUN, MOON or OFF (frost protection) from 00:00h to 00:30h. If SUN or MOON temperatures are selected the relevant luminous indicator will be lit. If OFF temperature ❄️ is selected both luminous indicators will be off.

Press the **+** key to go to the next interval. The display will show **00:30** intermittently and, again, press one of the three keys   ❄️ to allocate SUN, MOON or OFF (frost protection) from 00:30h to 01:00h or press **+** key directly if the existing temperature level is ok.

Repeat these steps allocating the desired temperatures levels over the 24 hours of the day. Press the **-** key at any time to modify a previous period. By reaching the **23:30** in the display and pressing **+** key the controller will store the program and will return to the previous mode.

At any time **PRG** key can be use also to store the program and return the previous mode.

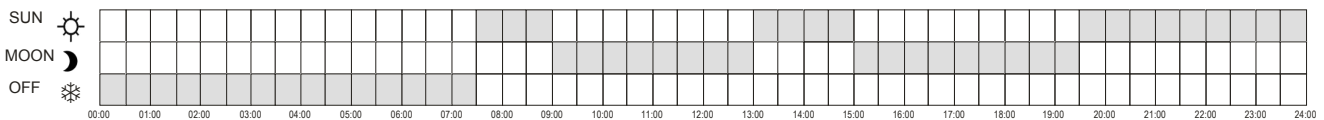

### EXAMPLE

Let's see an example of how to introduce a program with the above distribution of temperatures.

OFF from 24:00h to 7:30h in the morning. The heater will be on only if the temperature drops to 3°C.

SUN temperature from 7:30h to 9:00h.

MOON temperature from 9:00h to 13:00h.

SUN temperature from 13:00h to 15:00h.

MOON temperature from 15:00h to 19:30h.

SUN temperature from 19:30h to 24:00h.

1 - Press **PRG**

2 - Press ❄️

3 - Press **+** key

4 - Repeat steps 2 and 3 until display shows:

5 - Press 

6 - Press **+** key

7 - Press 

8 - Press **+** key

9 - Press 

10 - Press **+** key

11 - Press 

12 - Press **+** key

13 - Repeat steps 11 and 12 until display shows:

14 - Press 

15 - Press **+** key

16 - Repeat steps 14 and 15 until display shows:

17 - Press 

18 - Press **+** key

19 - Repeat steps 17 and 18 until display shows:

20 - Press 

21 - Press **+** key

22 - Repeat steps 20 and 21 until display shows::

23 - Press 

24 - Press **+** key

**00:00**

 ▼ Off

 ▲

**00:30**

**07:30**

 ▼ On

**08:00**

 ▼

**08:30**

 ▼

**09:00**

 ▲

**09:30**

**13:00**

 ▼

**13:30**

**15:00**

 ▲

**15:30**

**19:30**

 ▼

**20:00**

**23:30**

 ▼



**GRAB**





# Inertia Electric Radiators

## WEEKLY PROGRAMMES



It is possible to allocate different programs to different days of the week. To do this, the controller has to be upgrade from 24hr mode (factory default) to 24hr/7days mode as follows:

Move the selector to **0** position, the display will be Off. Press the  key and at the same time turn the selector to **P** position maintaining the  key at least five seconds. The display will show **P-SE** which means that weekly mode has been set.

SETTING THE DAY: Press the  key more than two seconds and the display will show the number of the day. Set the correct number, if required, by pressing **+** or **-** keys. Press the  key and the display will show now the time. Press again the  key and new values will be stored.



To check a programme or to make a new one press **PRG** key: The display will show **dia1**. Press again **PRG** key and the display will show **00:00** intermittently. Follow now the steps from DAILY PROGRAMMES section until the display shows again **dia1**. Repeat this process with the 7 days of the week. When the display shows **dia7** the weekly program will be stored by pressing **+** key.

If the display shows **dia1** then, pressing **+** key more than three seconds will copy the day 1 program to day 2 and so on.

It is possible to allocate any of the three temperature levels to all the intervals of any day maintaining the relevant    key until an audible signal is heard.

To turn back a controller from 24hr/7days to a single 24hr press **PRG** key more than six seconds. This will restore the factory default settings.

## KEYBOARD LOCK

Press the  key more than six seconds and the keyboard will be locked. The display will show **[ - - ]** and the controller will keep on working internally. To unlock the keyboard press again the  key more than six seconds.

## 4.- CLEANING AND MAINTENANCE



Clean and dust with a dry, soft cloth only when the unit is disconnected and cold.

Do not use solvents or abrasive products for cleaning.

This thermal radiator has been manufactured under an assured quality system using environment friendly processes.

Please take the heaters to a clean point once their useful life is finished, in order to recycle their materials in the right way.

## 5.- TROUBLESHOOTING

- **The thermal radiator does not heat.** Check the heater or the air inlets are not covered.  
Digital models: the display shows the time press the  key to switch on the heater. Check that the DAY or NIGHT temperatures are right.
- **The room does not reach the right temperature.** Check the selected temperature is in accordance with the desired temperature. Maybe the room needs more heating power.
- **DAY and NIGHT luminous indicators are lit at the same time.** Digital models: Continuous mode has been selected. Turn the knob to the "P" position to return to the Program mode if required.
- **The display shows "Err1" or "Err2"** Digital models: Contact the after sale service.
- **Only daily programmes.** The controller is in a single 24hr mode (factory default). See WEEKLY PROGRAMMES section to swift to 24hr/7days mode.
- **The keyboard is locked.** If the display shows **[ - - ]** the keyboard is locked. To unlock the keyboard press the  key more than six seconds.

# Inertia Electric Radiators

## WIRING

### **MODELS RF-P**

R heating element  
Ts safety cut out  
C three way selector

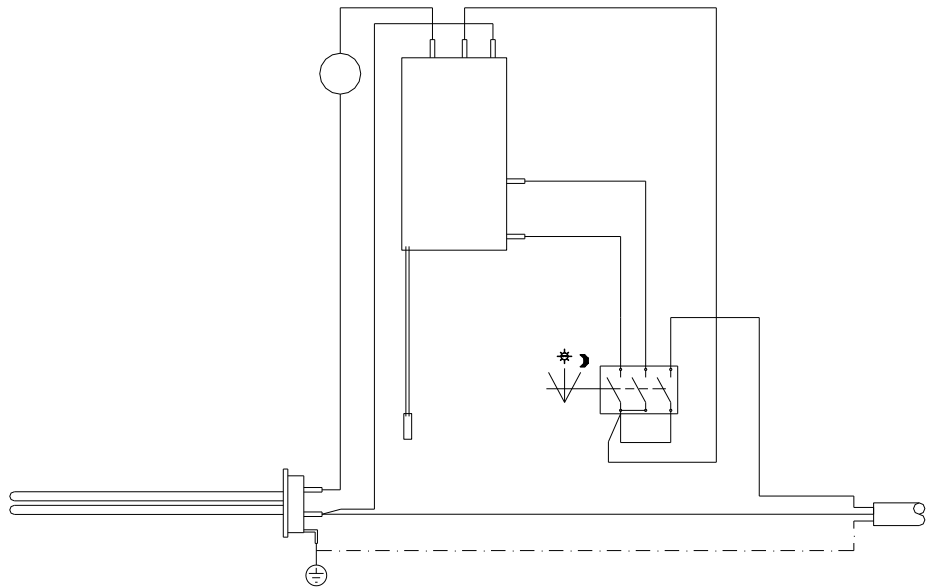

### **MODELS RF-F**

R heating element  
Ts safety cut out

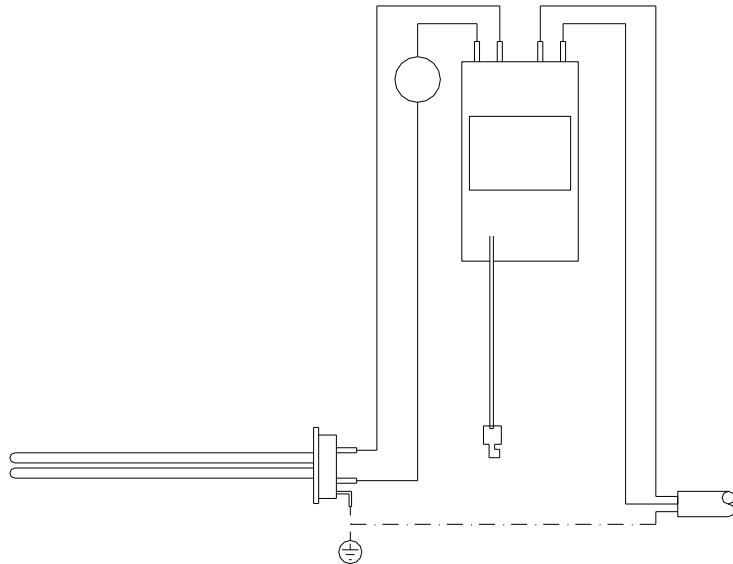

### **MODELS RF-E**

R heating element  
Ts safety cut out  
C three way selector

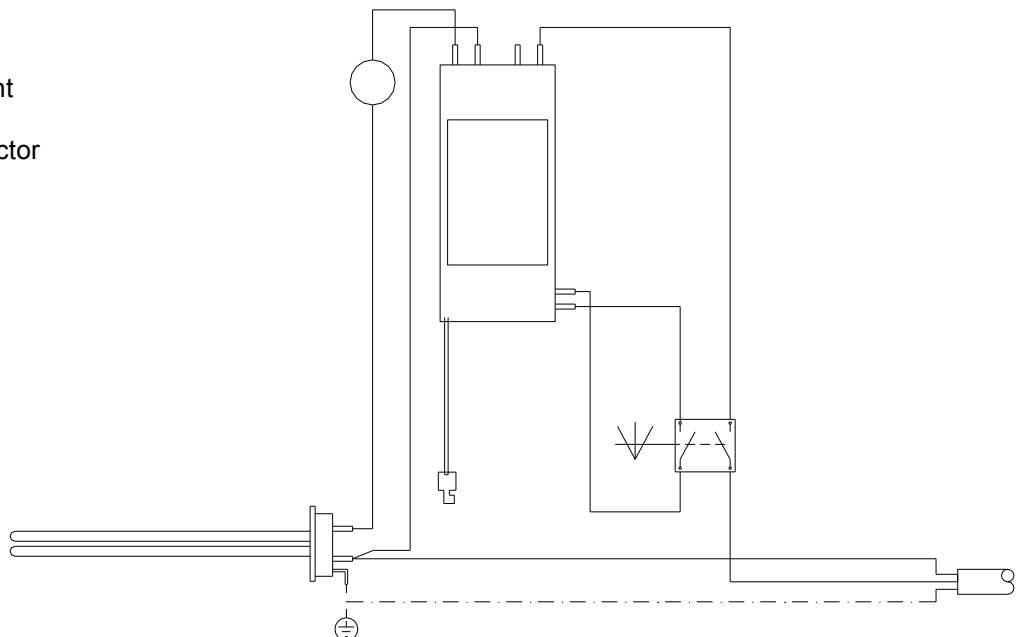

# Inertia Electric Radiators

---



**WARNING:** In order to avoid overheating do not cover the heater.



The symbol on the product or in its packaging indicates that this product may not be treated as household waste. Instead it shall be handed over to the applicable collection point for the recycling of electrical and electronic equipment. By ensuring this product is disposed of correctly, you will help prevent potential negative consequences for the environment and human health, which could otherwise be caused by inappropriate waste handling of this product. For more detailed information about recycling of this product, please contact your local city office, your household waste disposal service or the shop where you purchased the product. These instructions are only valid in the EU member states.

## NOTES



ELNUR UK Ltd.  
Unit 1, Brown Street North  
Leigh, Lancashire  
WN7 1BU  
[www.elnur.co.uk](http://www.elnur.co.uk)

Customer Service Department:  
Telephone +44(0)1942 670119  
[technical@elnur.co.uk](mailto:technical@elnur.co.uk)

Manufactured by:  
ELNUR, S.A.  
Madrid, Spain  
[www.elnur-global.com](http://www.elnur-global.com)  
[export@elnur-global.com](mailto:export@elnur-global.com)

Management System International Certifications:



ISO 9001



ISO 14001

*As a part of the policy of continuous product improvement Elnur reserves the right to alter specifications without notice.*

INSTALLATION INSTRUCTIONS AND USER GUIDE WEB VERSION